

OUTLINE DIMENSIONAL DRAWING

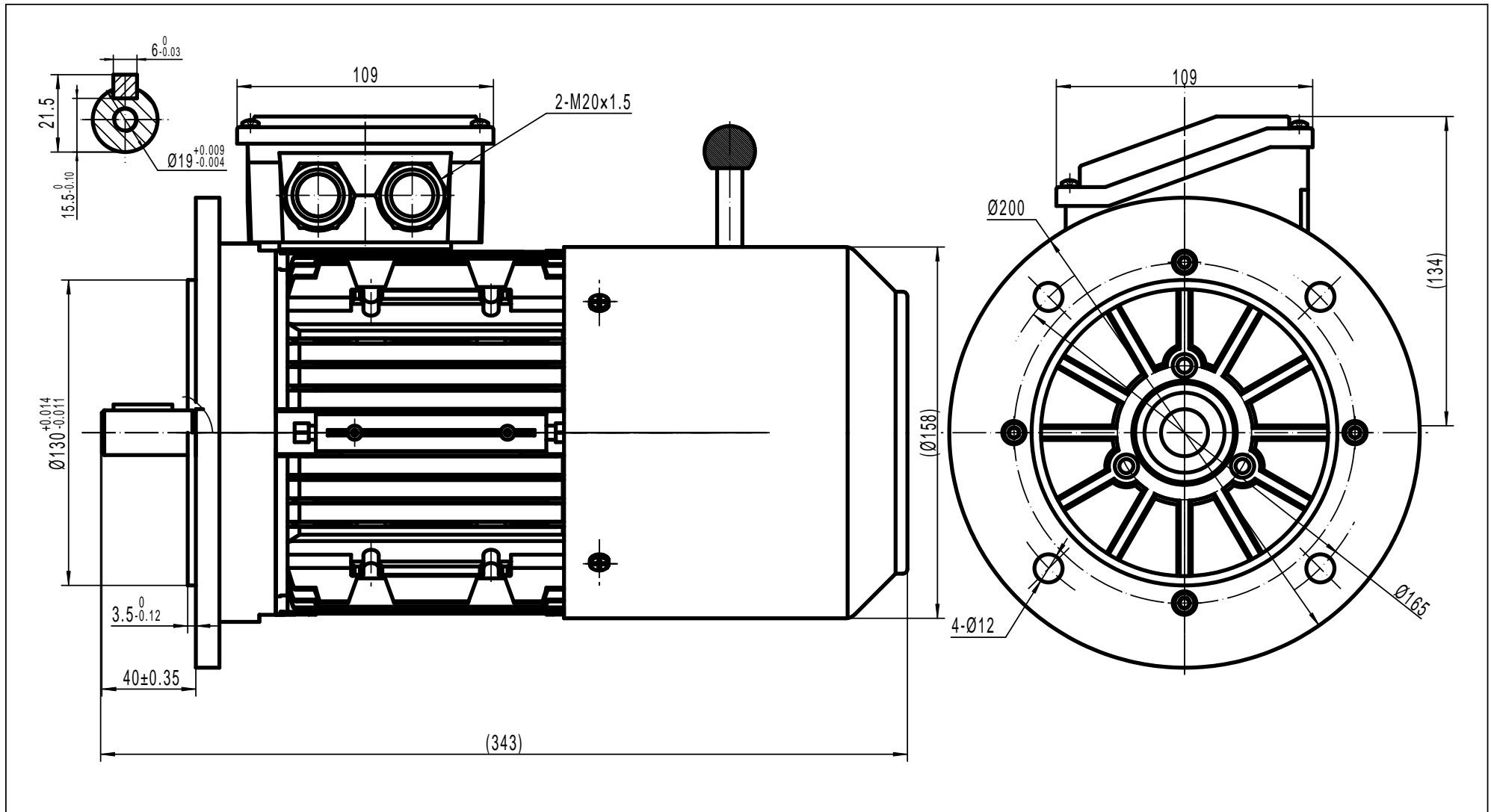

TECHTOP AUSTRALIA PTY LTD	
FRAME	TAIB 80A B5
DATE	DRAWING NO.
2013/10/22	1ST102.055.001-020 A